

X-ray Test Equipment



© 2024.09 Unfors RaySafe G21217, Rev F

All rights are reserved. Reproduction or transmission in whole or in part, in any form or by any means, electronic, mechanical or otherwise, is prohibited without the prior written consent of the copyright owner.

CONTENT

RaySafe X2.....	5
RaySafe X2 Prestige System	5
RaySafe X2 R/F & MAM System.....	8
RaySafe X2 R/F System.....	9
RaySafe X2 MAM System.....	9
RaySafe X2 CT System	10
RaySafe X2 Light System.....	10
RaySafe X2 Survey System.....	11
RaySafe X2 Volt System.....	11
RaySafe X2 Sensors.....	12
RaySafe X2 Upgrades.....	13
RaySafe X2 Accessories & Spare Parts	13
RaySafe X2 Solo	18
RaySafe X2 Solo R/F	18
RaySafe X2 Solo Dent.....	20
RaySafe X2 Solo Options & Upgrades	20
RaySafe X2 Solo Accessories & Spare Parts.....	21
RaySafe ThinX.....	24
RaySafe DXR+	25
Phantoms & Test Tools.....	26
Phantoms	26
CT	26
R/F	27
Test Tools.....	29
Specifications.....	31
RaySafe X2 & X2 Solo	
General Specifications.....	31
RaySafe X2 mAs Sensor	31
RaySafe X2 R/F Sensor	32
RaySafe X2 Mam Sensor	33
RaySafe X2 CT Sensor.....	34

X-ray Test Equipment Product Catalog

RaySafe X2 Volt Sensor	34
RaySafe X2 Light Sensor	35
RaySafe X2 Dent Sensor.....	36
RaySafe X2 Survey Sensor	37
RaySafe ThinX.....	38
RaySafe DXR+	39
RaySafe Pro-Fluoro 150 Phantom.....	39
RaySafe Pro-Digi Radiography Phantom.....	39
RaySafe P 3D Fluoro Phantom	40
RaySafe Pro-CT Dose Phantom.....	40
RaySafe Adult Head and Body CTDI Phantom.....	40
RaySafe Pro-Mam AEC BR Phantom	40
RaySafe Pro-Mam Accreditation Phantom	41
RaySafe Pro-Mam Biopsy Phantom.....	41
RaySafe Pro-Stand	41
RaySafe Pro-Slit Camera.....	42
Test Patterns	42
Pinholes.....	42

RaySafe X2

Part No / Model	RaySafe X2 Prestige System	
<p>5080633 / 1506013</p>	<p>RaySafe X2 Prestige R/F, M, C, L, mAs</p> <p>Complete system in standard case:</p> <p>RaySafe X2 Base Unit mAs RaySafe X2 R/F Sensor RaySafe X2 MAM Sensor RaySafe X2 CT Sensor RaySafe X2 Light Sensor RaySafe X2 Flexi Stand RaySafe X2 Bluetooth Adapter RaySafe X2 Power Supply Cables: 2 m, 5 m, 5 m ext USB, and 10 m mAs Various documentation Calibration certificates</p>	
<p>5080640 / 1506014</p>	<p>RaySafe X2 Prestige R/F, M, C, L</p> <p>Complete system in standard case:</p> <p>RaySafe X2 Base Unit RaySafe X2 R/F Sensor RaySafe X2 MAM Sensor RaySafe X2 CT Sensor RaySafe X2 Light Sensor RaySafe X2 Flexi Stand RaySafe X2 Bluetooth Adapter RaySafe X2 Power Supply Cables: 2 m, 5 m, and 5 m ext USB Various documentation Calibration certificates</p>	

Part No / Model		RaySafe X2 Prestige System
<p>5080745 / 1506035</p>	<p>RaySafe X2 Prestige R/F, M, C, S, mAs</p> <p>Complete system in standard case:</p> <p>RaySafe X2 Base Unit mAs RaySafe X2 R/F Sensor RaySafe X2 MAM Sensor RaySafe X2 CT Sensor RaySafe X2 Survey Sensor RaySafe X2 Flexi Stand RaySafe X2 Bluetooth Adapter RaySafe X2 Power Supply Cables: 2 m, 5 m, 5 m ext USB, and 10 m mAs Various documentation Calibration certificates</p>	
<p>5080750 / 1506036</p>	<p>RaySafe X2 Prestige R/F, M, C, S</p> <p>Complete system in standard case:</p> <p>RaySafe X2 Base Unit RaySafe X2 R/F Sensor RaySafe X2 MAM Sensor RaySafe X2 CT Sensor RaySafe X2 Survey Sensor RaySafe X2 Flexi Stand RaySafe X2 Bluetooth Adapter RaySafe X2 Power Supply Cables: 2 m, 5 m, and 5 m ext USB Various documentation Calibration certificates</p>	

Part No / Model		RaySafe X2 Prestige System
<p>5080761 / 1506037</p>	<p>RaySafe X2 Prestige R/F, M, L, S, mAs</p> <p>Complete system in standard case:</p> <p>RaySafe X2 Base Unit mAs RaySafe X2 R/F Sensor RaySafe X2 MAM Sensor RaySafe X2 Light Sensor RaySafe X2 Survey Sensor RaySafe X2 Flexi Stand RaySafe X2 Bluetooth Adapter RaySafe X2 Power Supply Cables: 2 m, 5 m, 5 m ext USB, and 10 m mAs Various documentation Calibration certificates</p>	
<p>5080777 / 1506038</p>	<p>RaySafe X2 Prestige R/F, M, L, S</p> <p>Complete system in standard case:</p> <p>RaySafe X2 Base Unit RaySafe X2 R/F Sensor RaySafe X2 MAM Sensor RaySafe X2 Light Sensor RaySafe X2 Survey Sensor RaySafe X2 Flexi Stand RaySafe X2 Bluetooth Adapter RaySafe X2 Power Supply Cables: 2 m, 5 m, and 5 m ext USB Various documentation Calibration certificates</p>	

Part No / Model		RaySafe X2 R/F & MAM System
<p>5080595 / 1506009</p>	<p>RaySafe X2 R/F, MAM, mAs</p> <p>Complete system in standard case:</p> <p>RaySafe X2 Base Unit mAs RaySafe X2 R/F Sensor RaySafe X2 MAM Sensor RaySafe X2 Flexi Stand RaySafe X2 Power Supply Cables: 2 m, 5 m, 5 m ext USB, and 10 m mAs Various documentation Calibration certificates</p>	
<p>5080602 / 1506010</p>	<p>RaySafe X2 R/F, MAM</p> <p>Complete system in standard case:</p> <p>RaySafe X2 Base Unit RaySafe X2 R/F Sensor RaySafe X2 MAM Sensor RaySafe X2 Flexi Stand RaySafe X2 Power Supply Cables: 2 m, 5 m, and 5 m ext USB Various documentation Calibration certificates</p>	

Part No / Model		RaySafe X2 R/F System
5080517 / 1506001	RaySafe X2 R/F, mAs	
	Complete system in standard case: RaySafe X2 Base Unit mAs RaySafe X2 R/F Sensor RaySafe X2 Flexi Stand RaySafe X2 Power Supply Cables: 2 m, 5 m, 5 m ext USB, and 10 m mAs Various documentation Calibration certificates	
5080521 / 1506002	RaySafe X2 R/F	
	Complete system in standard case: RaySafe X2 Base Unit RaySafe X2 R/F Sensor RaySafe X2 Flexi Stand RaySafe X2 Power Supply Cables: 2 m, 5 m, and 5 m ext USB Various documentation Calibration certificates	
Part No / Model		RaySafe X2 MAM System
5080539 / 1506003	RaySafe X2 MAM, mAs	
	Complete system in standard case: RaySafe X2 Base Unit mAs RaySafe X2 MAM Sensor RaySafe X2 Flexi Stand RaySafe X2 Power Supply Cables: 2 m, 5 m, 5 m ext USB, and 10 m mAs Various documentation Calibration certificates	
5080542 / 1506004	RaySafe X2 MAM	
	Complete system in standard case: RaySafe X2 Base Unit RaySafe X2 MAM Sensor RaySafe X2 Flexi Stand RaySafe X2 Power Supply Cables: 2 m, 5 m, and 5 m ext USB Various documentation Calibration certificates	

Part No / Model		RaySafe X2 CT System
5080574 / 1506007	RaySafe X2 CT, mAs	
	Complete system in standard case: RaySafe X2 Base Unit mAs RaySafe X2 CT Sensor RaySafe X2 Flexi Stand RaySafe X2 Power Supply Cables: 2 m, 5 m, 5 m ext USB, and 10 m mAs Various documentation Calibration certificates	
5080588 / 1506008	RaySafe X2 CT	
	Complete system in standard case: RaySafe X2 Base Unit RaySafe X2 CT Sensor RaySafe X2 Flexi Stand RaySafe X2 Power Supply Cables: 2 m, 5 m, and 5 m ext USB Various documentation Calibration certificates	
Part No / Model		RaySafe X2 Light System
5080706 / 1506031	RaySafe X2 Light, mAs	
	Complete system in standard case: RaySafe X2 Base Unit mAs RaySafe X2 Light Sensor RaySafe X2 Flexi Stand RaySafe X2 Power Supply Cables: 2 m, 5 m, 5 m ext USB, and 10 m mAs Various documentation Calibration certificates	
5080714 / 1506032	RaySafe X2 Light	
	Complete system in standard case: RaySafe X2 Base Unit RaySafe X2 Light Sensor RaySafe X2 Flexi Stand RaySafe X2 Power Supply Cables: 2 m, 5 m, and 5 m ext USB Various documentation Calibration certificates	

Part No / Model		RaySafe X2 Survey System
5080723 / 1506033	RaySafe X2 Survey, mAs	
	Complete system in standard case: RaySafe X2 Base Unit mAs RaySafe X2 Survey Sensor RaySafe X2 Flexi Stand RaySafe X2 Power Supply Cables: 2 m, 5 m, 5 m ext USB, and 10 m mAs Various documentation Calibration certificates	
5080738 / 1506034	RaySafe X2 Survey	
	Complete system in standard case: RaySafe X2 Base Unit RaySafe X2 Survey Sensor RaySafe X2 Flexi Stand RaySafe X2 Power Supply Cables: 2 m, 5 m, and 5 m ext USB Various documentation Calibration certificates	
Part No / Model		RaySafe X2 Volt System
5307115 / 1506059	RaySafe X2 Volt mAs	
	Complete system in standard case: RaySafe X2 Base Unit mAs RaySafe X2 Volt Sensor RaySafe X2 Flexi Stand RaySafe X2 Power Supply Cables: 2 m, 5 m, 5 m ext USB, and 10 m mAs Various documentation Calibration certificates	
5307103 / 1506058	RaySafe X2 Volt	
	Complete system in standard case: RaySafe X2 Base Unit RaySafe X2 Volt Sensor RaySafe X2 Flexi Stand RaySafe X2 Power Supply Cables: 2 m, 5 m, and 5 m ext USB Various documentation Calibration certificates	

Part No / Model		RaySafe X2 Sensors
4559135 / 1252010	RaySafe X2 R/F Sensor	
	Multi-parameter sensor with stacked diodes (includes calibration certificates)	
4559147 / 1252020	RaySafe X2 MAM Sensor	
	Multi-parameter sensor with stacked diodes (includes calibration certificates). Dose/Dose Rate & HVL: Mo/Al, Mo/Cu, Mo/Mo, Mo/Rh, Rh/Ag, Rh/Al, Rh/Cu, Rh/Rh, W/Ag, W/Al, W/Cu, W/Rh, W/Ti. kVp: Mo/Cu, Mo/Mo, Mo/Rh, Rh/Ag, W/Ag, W/Al, W/Cu, W/Rh, W/Ti. Supports scanning mammography	
4559158 / 1252030	RaySafe X2 CT Sensor	
	100 mm pencil shaped CT sensor for dose, dose length product, dose rate and time. Includes calibration certificates	
4559164 / 1252040	RaySafe X2 Light Sensor	
	Luminance and illuminance sensor (includes calibration certificates)	
4673386 / 1252060	RaySafe X2 Survey Sensor	
	For performing leakage measurements and for measuring scattered radiation from X-ray systems. The sensitive survey sensor can also be used to measure low dose rates in the primary field. Includes calibration certificates	
5220340 / 1252070	RaySafe X2 Volt Sensor	
	The RaySafe X2 Volt sensor is used for measuring voltage from the output voltage test points on X-ray machines. Includes calibration certificates	

Part No / Model		RaySafe X2 Upgrades
5092863 / 1916001	Upgrade to RaySafe X2 Base Unit with mAs	
	Upgrade of the RaySafe X2 Base Unit to enable invasive mA and mAs measurements	

Part No / Model		RaySafe X2 Accessories & Spare Parts
4560024 / 1922052	RaySafe X2 Storm Case	
	Heavy duty, waterproof case with custom inlay for a complete RaySafe X2 system	
4560036 / 1922053	RaySafe X2 Storm Case System Option¹⁾	
	Upgrade from a standard case to a storm case	
4560013 / 1922050	RaySafe X2 Standard Alu Case	
	Lockable aluminium case with customized inlay	
4908594 / 1922093	RaySafe X2 Storm Case for GE Kit	
	Storm Case for a complete RaySafe X2 system with room for RaySafe X2 GE holders	
4908608 / 1922111	RaySafe X2 Storm Case for GE Kit System Option¹⁾	
	Upgrade to the RaySafe X2 Storm Case for GE kit when purchasing a RaySafe X2 system	

1) Only available when ordering a new system.

Part No / Model		RaySafe X2 Accessories & Spare Parts
4559783 / 1902080	RaySafe X2 Flexi Stand	
	Flexible stand and holder for positioning RaySafe X2 sensors	
4959583 / 1902097	RaySafe X2 Panoramic Holder	
	Holder for accurate positioning of the RaySafe X2 DENT or R/F sensor on panoramic machines. Includes 10 gafchromic film slips (part 5600136)	
4559790 / 1902084	RaySafe X2 Vacuum Holder	
	Sensor holder with suction cup for various placements. Attached with a flexible arm and compatible with parts from the RaySafe X2 Flexi Stand	
4787978 / 1902093	RaySafe X2 Suction Cup Holder	
	Sensor holder for easy mounting and placement in various applications	
4559803 / 1902087	RaySafe X2 Scanning MAM Holder	
	Sensor holder for easy placement of the RaySafe X2 MAM Sensor when measuring on Scanning MAM, (e.g. Philips Microdose)	
4718087 / 1902091	RaySafe X2 Light Holder	
	Sensor holder for mounting the RaySafe X2 Light sensor on a monitor	

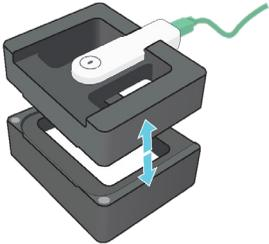
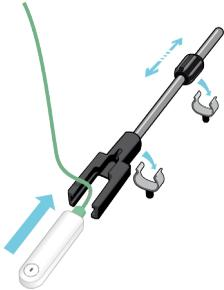
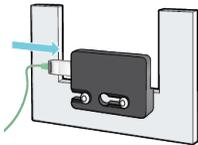
Part No / Model		RaySafe X2 Accessories & Spare Parts
4854002 / 1902088	RaySafe X2 Mammography Holder GE	
	Holder which fits the holder provided by GE. For the RaySafe X2 MAM Sensor on mammography machines from GE. Sensor position will be identical to ion-chamber setup	
4854016 / 1902089	RaySafe X2 Vascular Holder GE	
	Holder which adapts to the holder provided by GE. To be used with the RaySafe X2 R/F Sensor on angiography machines from GE. Sensor position will be identical to an ion-chamber setup	
4854025 / 1902090	RaySafe X2 Radiography Holder GE	
	Sensor holder which adapts to the holder provided by GE. To be used with the RaySafe X2 R/F Sensor on radiography machines from GE	
4853992 / 1922096	RaySafe X2 Power Supply Kit	
	International 5 V power supply including the most common power plugs	
4560097 / 3410034	USB Cable, 2 m, Green	
	USB to USB micro for sensor and PC connections	

Part No / Model		RaySafe X2 Accessories & Spare Parts
4560085 / 3410033	USB Cable, 5 m, Blue	
	USB to USB micro for sensor and PC connections	
4560106 / 3410035	USB Cable, 5 m Extender	
	USB male to USB female active extender to enable a 10 m long sensor cable	
4559674 / 1902026	mAs Cable, 2 m	
	Short mAs cable	
4559688 / 1902028	mAs Cable, 10 m	
	Long mAs cable	
4560060 / 1922064	RaySafe X2 Bluetooth Adapter	
	USB Bluetooth adapter for wireless communication to a PC	
4560072 / 1922068	RaySafe X2 GX Light Adapter	
	A GX adapter for Philips image intensifiers. To be used with the RaySafe X2 Light Sensor	

Part No / Model		RaySafe X2 Accessories & Spare Parts
5234544 / 1902103	RaySafe X2 Volt Cable - 10:1 Probe	
	The 10:1 probe attenuates the input signal by a factor of 10. Can be suitable for certain applications and machines e.g. Optima	
5234503 / 1902099	RaySafe X2 Volt Cable - Banana Connectors	
	For connection of the RaySafe X2 Volt Sensor to the voltage test points on X-ray machines	

RaySafe X2 Solo

RaySafe X2 Solo R/F

Part No / Model	RaySafe X2 Solo R/F Systems	
<p>5216000 / 1506053</p>	<p>RaySafe X2 Solo R/F with mAs, HVL, and Flexi Stand</p> <p>RaySafe X2 Base Unit mAs RaySafe X2 R/F Sensor with active compensation: RaySafe X2 Power Supply RaySafe X2 Solo Case RaySafe X2 Flexi Stand Cables: 2 m, 5 m, 5 m ext USB, and 10 m mAs Various documentation Calibration certificates</p> <p>W/AI beam quality. Sensor has active compensation. Measures kVp, dose, rate, pulses, time, mA, mAs, and HVL</p>	
<p>5080853 / 1506047</p>	<p>RaySafe X2 Solo R/F with mAs and HVL</p> <p>RaySafe X2 Base Unit mAs RaySafe X2 R/F Sensor with active compensation: RaySafe X2 Power Supply RaySafe X2 Solo Case Cables: 2 m, 5 m, 5 m ext USB, and 10 m mAs Various documentation Calibration certificates</p> <p>W/AI beam quality. Sensor has active compensation. Measures kVp, dose, rate, pulses, time, mA, mAs, and HVL</p>	

Part No / Model		RaySafe X2 Solo R/F Systems
5264705 / 1506055	RaySafe X2 Solo R/F with HVL	
	RaySafe X2 Base Unit RaySafe X2 R/F Sensor with active compensation: RaySafe X2 Power Supply RaySafe X2 Solo Case Cables: 2 m, 5 m, and 5 m ext USB Various documentation Calibration certificates W/AI beam quality. Sensor has active compensation. Measures kVp, dose, rate, pulses, time, and HVL	
5080792 / 1506041	RaySafe X2 Solo R/F with mAs	
	RaySafe X2 Base Unit mAs RaySafe X2 R/F Sensor with active compensation: RaySafe X2 Power Supply RaySafe X2 Solo Case Cables: 2 m, 5 m, 5 m ext USB, and 10 m mAs Various documentation Calibration certificates W/AI beam quality. Sensor has active compensation. Measures: kVp, dose, rate, pulses, time, mA, and mAs	
5080809 / 1506042	RaySafe X2 Solo R/F	
	RaySafe X2 Base Unit RaySafe X2 R/F Sensor RaySafe X2 Power Supply RaySafe X2 Solo Case Cables: 2 m, 5 m, and 5 m ext USB Various documentation Calibration certificates W/AI beam quality. Sensor has active compensation. Measures: kVp, dose, rate, pulses, and time	

RaySafe X2 Solo Dent

Part No / Model	RaySafe X2 Solo Dent Systems	
5080811 / 1506043	<p>RaySafe X2 Solo DENT with mAs</p> <p>RaySafe X2 Base Unit mAs RaySafe X2 Dent Sensor RaySafe X2 Panoramic holder RaySafe X2 Power Supply RaySafe X2 Solo Case Cables: 2 m, 5 m, 5 m ext USB, and 10 m mAs Various documentation Calibration certificates</p> <p>W/AI beam quality. Measures kVp, dose, rate, pulses, time, mA, and mAs</p>	
5080827 / 1506044	<p>RaySafe X2 Solo DENT</p> <p>RaySafe X2 Base Unit RaySafe X2 Dent Sensor RaySafe X2 Panoramic holder RaySafe X2 Power Supply RaySafe X2 Solo Case Cables: 2 m, 5 m, and 5 m ext USB Various documentation Calibration certificates</p> <p>W/AI beam quality. Measures kVp, dose, rate, pulses, and time</p>	

RaySafe X2 Solo Options & Upgrades

Part No / Model	Options & Upgrades
5085445 / NA	<p>RaySafe X2 Solo HVL</p> <p>Get HVL and Total Filtration simultaneously with the other parameters</p>
4967755 / 1916019	<p>RaySafe X2 Solo to RaySafe X2 Upgrade</p> <p>Upgrade of the RaySafe X2 Solo Base Unit to a full RaySafe X2 Base unit which can handle all types of RaySafe X2 sensors.</p>

Part No / Model		RaySafe X2 Solo Accessories & Spare Parts
4560024 / 1922052	RaySafe X2 Storm Case	
	Heavy duty, waterproof case with custom inlay for a complete RaySafe X2 system	
4560036 / 1922053	RaySafe X2 Storm Case System Option¹⁾	
	Upgrade from standard case to storm case	
4959576 / 1922115	RaySafe X2 Solo R/F / DENT Standard Alu Case	
	Lockable aluminium case with customized inlay with space for RaySafe X2 Panoramic Holder	
4560013 / 1922050	RaySafe X2 Standard Alu Case	
	Lockable aluminium case with customized inlay	
4908594 / 1922093	RaySafe X2 Storm Case for GE Kit	
	Storm Case for a complete RaySafe X2 system with room for RaySafe X2 GE holders	
4908608 / 1922111	RaySafe X2 Storm Case for GE Kit System Option¹⁾	
	Upgrade to the RaySafe X2 Storm Case for GE kit when purchasing a RaySafe X2 system	

1) Only available when ordering a new system.

Part No / Model		RaySafe X2 Solo Accessories & Spare Parts
4559783 / 1902080	RaySafe X2 Flexi Stand	
	Flexible stand and holder for positioning RaySafe X2 sensors	
4959583 / 1902097	RaySafe X2 Panoramic Holder	
	Holder for accurate positioning of the RaySafe X2 DENT or R/F sensor on panoramic machines. Includes 10 gafchromic film slips (part 5600136)	
4560114 / 5600136	Gafchromic Film XR-QA2 - 10 pcs	
	To be used with the RaySafe X2 Panoramic holder	
4559790 / 1902084	RaySafe X2 Vacuum Holder	
	Sensor holder with suction cup for various placements. Attached with a flexible arm and compatible with parts from the RaySafe X2 Flexi Stand	
4787978 / 1902093	RaySafe X2 Suction Cup Holder	
	Sensor holder for easy mounting and placement in various applications	
4853992 / 1922096	RaySafe X2 Power Supply Kit	
	International 5 V power supply including the most common power plug	

Part No / Model		RaySafe X2 Solo Accessories & Spare Parts
4560097 / 3410034	USB Cable, 2 m, Green	
	USB to USB micro for sensor and PC connections	
4560085 / 3410033	USB Cable, 5 m, Blue	
	USB to USB micro for sensor and PC connections	
4560106 / 3410035	USB Cable, 5 m Extender	
	USB male to USB female active extender to enable a 10 m long sensor cable	
4559674 / 1902026	mAs Cable, 2 m	
	Short mAs cable	
4559688 / 1902028	mAs Cable, 10 m	
	Long mAs cable	
4560060 / 1922064	RaySafe X2 Bluetooth Adapter	
	USB Bluetooth adapter for wireless communication to a PC	

RaySafe ThinX

Part No / Model	RaySafe ThinX	
4559199 / 1302024	RaySafe ThinX RAD	
	Fully automatic X-ray meter for radiographic applications. Measures kVp, dose, rate, time, pulses and HVL. Includes calibration certificate, user's manual and a soft protective case.	
4559208 / 1302025	RaySafe ThinX RAD kVp	
	Fully automatic X-ray meter for radiographic applications. Measures kVp, time, and pulses. Includes calibration certificate, user's manual and a soft protective case	
4559213 / 1302026	RaySafe ThinX RAD Dose	
	Fully automatic X-ray meter for radiographic applications. Measures dose, rate, time, pulses and HVL. Includes calibration certificate, user's manual and a soft protective case	
4559186 / 1302023	RaySafe ThinX Intra	
	Fully automatic X-ray meter for dental intraoral measurements. Measures kVp, dose, rate, time, pulses and HVL. Includes calibration certificate, user's manual and a soft protective case	
4588527 / 1302024-R	RaySafe ThinX RAD - R version	
	Fully automatic X-ray meter for radiographic applications. Measures kVp, dose, rate, time, pulses and HVL. Includes calibration certificate, user's manual and a soft protective case	
4588530 / 1302025-R	RaySafe ThinX RAD kVp - R version	
	Fully automatic X-ray meter for radiographic applications. Measures kVp, time, and pulses. Includes calibration certificate, user's manual and a soft protective case	

<p>4559213 / 1302026-R</p>	<p>RaySafe ThinX RAD Dose - R</p> <p>Fully automatic X-ray meter for radiographic applications. Measures dose, rate, time, pulses and HVL. Includes calibration certificate, user's manual and a soft protective case</p>	
<p>4588553 / 1302023-R</p>	<p>RaySafe ThinX Intra - R</p> <p>Fully automatic X-ray meter for dental intraoral measurements. Measures kVp, dose, rate, time, pulses and HVL. Includes calibration certificate, user's manual and a soft protective case</p>	

RaySafe DXR+

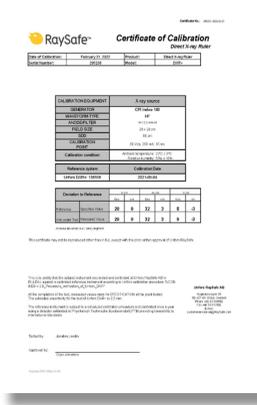
<p>Part No / Model DXR+</p>		
<p>4558862 / 1151011</p>	<p>RaySafe DXR+</p> <p>Direct X-ray ruler for X-ray/light field alignment and beam centering in R/F and mammography applications</p>	
<p>5101931 / 5610029</p>	<p>Certificate of Calibration DXR+</p> <p>Certification that the specific DXR+ instrument was tested and calibrated at Unfors RaySafe AB against a calibrated reference instrument.</p>	

Phantoms & Test Tools

Phantoms

Part No / Model	CT	
<p>4717403 / 1921058</p>	<p>RaySafe Pro-CT Dose Phantom</p> <p>Nested head, body and pediatric phantom with holes to place a CT sensor for CTDI measurements. Adult body is 32 cm, adult head/pediatric body is 16 cm, and pediatric head is 10 cm. Frosted PMMA with density 1.19 g/cm³. Delivered in a wheel carried Storm Case with inlay to fit a RaySafe X2 Base Unit, CT and R/F sensor</p>	
<p>4559815 / 1921046</p>	<p>Adult Head and Body CTDI Phantom</p> <p>Body with diameter 32 cm and 4 holes for CTDI and head phantom with diameter 16 cm and 5 holes for CTDI. Frosted PMMA with density 1.19 g/cm³. Delivered in a wheel carried Storm Case with inlay to fit a RaySafe X2 Base Unit, CT and R/F sensor</p>	
<p>4712548 / 1921056</p>	<p>Head & Body CT Phantom, GE</p> <p>Body with diameter 32 cm and 4 holes for CTDI and head phantom with diameter 16 cm and 5 holes for CTDI. Frosted PMMA with density 1.19 g/cm³. Includes a couch adapter for GE for easy mounting. Delivered in a wheel carried Storm Case with inlay to fit a RaySafe X2 Base Unit, CT and R/F sensor</p>	

Part No / Model	R/F	
<p>5102570 / 1921059</p>	<p>RaySafe Pro-Fluoro 150 Phantom</p> <p>Made for acceptance and constancy tests of digital and analog radiography and fluoroscopy equipment. Suitable for routine quality checks on over-couch tubes, under-couch tubes and C-arms. Used for collimation/beam alignment, dynamic range, spatial and contrast resolution, homogeneity, and beam perpendicularity. Comes with holder for easy positioning on a table or chest wall. Complies with DIN 6868-150 and DIN 6868-4. Comes with a rugged case with space for a RaySafe X2 system</p>	
<p>4717397 / 1922078</p>	<p>RaySafe Pro-Digi Radiography Phantom</p> <p>Made for acceptance and constancy tests of digital radiography equipment. Used for collimation/beam alignment, dynamic range, spatial resolution, contrast resolution, homogeneity. Includes Al and Cu filter, alignment cone, bucky mounting device. Complies with DIN 6868-13, and DIN 6868-58. Delivered in a rugged case</p>	
<p>4712527 / 1921052</p>	<p>RaySafe P 3D Fluoro Phantom</p> <p>Is used to test the cone beam functionality of fluoroscopic X-ray systems. After carrying out image quality testing on 2D image acquisition with RaySafe Pro-Fluoro 150, this phantom is used to evaluate the 3D capability of 3D reconstruction module. Complies with DIN 6868-150. Delivered in a rugged case</p>	

<p>5517583 / 18-220-01</p>	<p>RaySafe Pro-Mam Accreditation Phantom</p> <p>The Mammography Accreditation Phantom is designed to meet the Mammography Quality Standards Act (MQSA) and the American College of Radiology (ACR) Quality Control Programs for diagnostic testing.* It is used for Full-field Digital Mammography (FFDM) machines.</p>	
<p>5517601 / 18-250-01</p>	<p>RaySafe Pro-Mam Biopsy Phantom</p> <p>This phantom was designed to provide a fast and easy way to test image quality on digital biopsy mammography units without having to do multiple exposures.</p>	
<p>5517590 / 18-238-01</p>	<p>RaySafe Pro-Mam AEC BR Phantom</p> <p>Set of slabs made of tissue equivalent resin for testing Automatic Exposure Control (AEC) of mammography systems.</p>	

* In the process of being accredited.

Test Tools

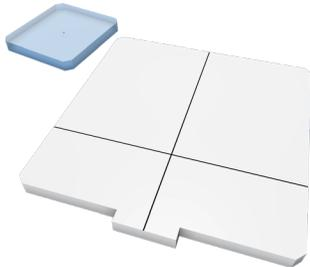
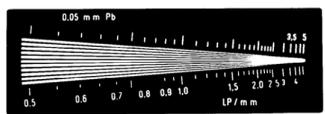
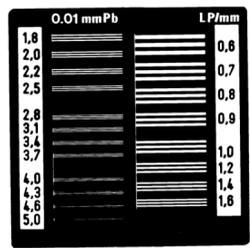
Part No / Model	Test Tools	
4829300 / 1922103	<p>RaySafe Pro-Slit Camera</p> <p>Slit camera for measuring focal spot size on most machines. 0.01 mm wide and 10 mm long slit</p>	
4829317 / 1922104	<p>RaySafe Pro-Stand Full</p> <p>Holder with adjustable height, 350-600 mm, to be used with the RaySafe Pro-Slit Camera or our pinholes. Can be used as a holder when doing manual HVL measurements. Can be tilted 10 degrees for accurate positioning on mammography machines. Includes a tool for easy alignment. Comes in a rugged case</p>	
4829321 / 1922110	<p>RaySafe Pro-Stand Basic</p> <p>Holder with adjustable height, 350-600 mm, to be used with the RaySafe Pro-Slit Camera or our pinholes. Can be used as a holder when doing manual HVL measurements. Comes in a light-weight card board box</p>	
3263272 / 07-501-2000	<p>High-precision X-ray Test Pattern 07-501-2000</p> <p>1.0-4.8 LP/mm, 0.1 mm Pb</p>	
3263381 / 07-523-2000	<p>High-precision X-ray Test Pattern 07-523-2000</p> <p>0.5-5.0 LP/mm, 0.1 mm Pb</p>	
3263453 / 07-535	<p>High-precision X-ray Test Pattern 07-535</p> <p>0.6-5.0 LP/mm, 0.05 mm Pb</p>	

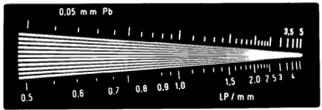
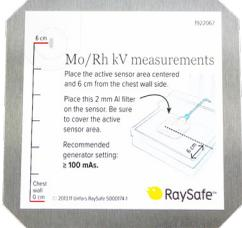
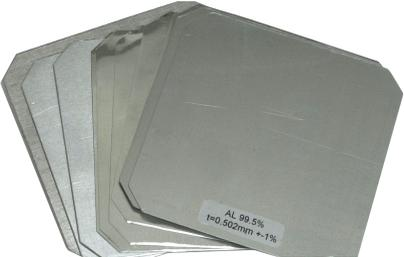
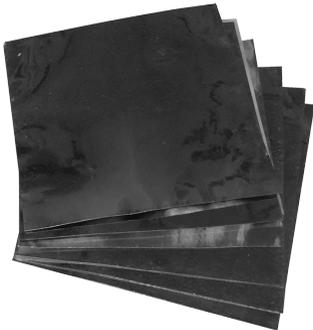
<p>3263482 / 07-539</p>	<p>High-precision X-ray Test Pattern 07-539 1.5-20.0 LP/mm, 0.025 mm Pb</p>	
<p>3263803 / 07-633</p>	<p>X-ray Pinhole Assembly 07-633 0.010 mm (for focal spot size 0.5-1.0 mm)</p>	
<p>3263674 / 07-613</p>	<p>X-ray Pinhole Assembly 07-613 0.030 mm (for focal spot size < 1.0 mm)</p>	
<p>3263695 / 07-617</p>	<p>X-ray Pinhole Assembly 07-617 0.075 mm (for focal spot size 1.0-2.5 mm)</p>	
<p>3263663 / 07-611</p>	<p>X-ray Pinhole Assembly 07-611 0.100 mm (for focal spot size > 2.5 mm)</p>	
<p>4712697 / 1922067</p>	<p>RaySafe X2 MAM Filter, 2 mm Al For kV measurements on Mo/Rh and W/Al above 40 kV</p>	
<p>4559591 / 1901017</p>	<p>HVL Filter Set MAM/RAD 90x90 mm 99.5 % Al filter set (1 pc 2 mm, 2 pcs 1 mm, 2 pcs 0.5 mm, 5 pcs 0.1 mm).</p>	
<p>4559600 / 1901018</p>	<p>HVL Filter Set RAD/DENT 90x90 mm 99.5 % Al filter set (1 pc 2 mm, 2 pcs 1 mm, 2 pcs 0.5 mm)</p>	
<p>4559826 / 1921047</p>	<p>HVL FILTER SET WITH HIGH PURITY 100x100 mm 99.999% Al filter set (6 pcs 0.1 mm). Individually measured. Thickness is noted on each filter with a tolerance of 5%</p>	

Specifications

RaySafe X2 & X2 Solo General Specifications

EMC	According to IEC 61326-1
Safety	According to IEC 61010-1
X-ray Meter Standard	Complies with IEC 61674
Exposures Needed	One
USB Cables	2 m (6.6 ft), 5 m (16.4 ft) and 5 m active extender
Base Unit Size	34 x 85 x 154 mm (1.3 x 3.3 x 6.1 in)
Base Unit Weight	521 g (18.4 oz)
Operating Temperature	15 – 35 °C (59 – 95 °F)
Storage Temperature	-25 – 70 °C (-13 – 158 °F)
Power Source	Rechargeable Li ion battery
Battery Time	~ 10 hours intensive usage
Battery Tested	According to UN 38.3
Display	4.3" LCD with capacitive touch
Memory	~ 10000 latest exposures
Software	RaySafe View for data handling and analysis. Also exports data to Microsoft Excel.
PTB Certificate	DE-17-M-PTB-0053

RaySafe Uncertainty Definition

The expanded uncertainty is stated as the combined uncertainty of measurement multiplied by the coverage factor $k=2$, which assuming a normal distribution has a coverage probability of 95 % (complies with GUM by ISO (1995, ISBN 92-67-10188-9)).

Instrument specifications are subject to purchased configuration. All specifications may change without prior notice.

RaySafe X2 mAs Sensor

mAs	
Range	0.001 – 9999 mAs
Resolution	0.001 mAs
Uncertainty	1%
mA	
Range (Peak)	0.1 – 1500 mA
Resolution	0.01 mA
Uncertainty	1%
Time	
Range	1 ms – 999 s
Resolution	0.1 ms
Bandwidth	1 kHz
Uncertainty	0.5%
Pulses	
Range	1 – 9999 pulses
Resolution	1 pulse
Pulse Rate	
Range	0.1 – 200 pulses/s
Resolution	0.1 pulse/s
mAs/Pulse	
Range	0.001 – 9999 mAs
Resolution	0.001 mAs
Uncertainty	1%
Waveform	
Resolution	125 μ s*
Bandwidth	1 kHz
* Automatically reduced for exposures longer than 3 s	

RaySafe X2 R/F Sensor

Weight	42 g (1.5 oz)
Size	14 x 22 x 79 mm (0.5 x 0.9 x 3.1 in.)
Sensitivity Angle	Dose, kVp, HVL: 10° See images below
Active Compensation	
Beam quality independent for the following ranges:	
Dose/Dose Rate	40 – 150 kVp, 1 – 14 mm Al HVL
kVp	40 – 150 kVp, up to 1 mm Cu
TF	60 – 120 kVp, up to 1 mm Cu
Dose	
Range	1 nGy – 9999 Gy (0.1 μR – 9999 R)
Uncertainty	5% or 5 nGy (0.5 μR)
Dose Rate	
Range	1 nGy/s – 500 mGy/s (5 μR/min – 3400 R/min)
Resolution	1 nGy/s (5 μR/min)
Trig Level	50 nGy/s (340 μR/min)
Uncertainty	5% or 10 nGy/s (70 μR/min) x duty cycle
kVp	
Range	40 – 150 kVp
Minimum Dose	50 μGy (6 mR)
Minimum Dose Rate (Peak)	10 μGy/s (70 mR/min)
Uncertainty	2%
HVL	
Range	1 – 14 mm Al
Minimum Dose	1 μGy (120 μR)
Minimum Dose Rate (Peak)	0.5 μGy/s (3.5 mR/min) at > 70 kV 2.5 μGy/s (17 mR/min) at 50 kV
Uncertainty	10%

Total Filtration	
Range	1.5 – 35 mm Al
Minimum Dose	50 μGy (6 mR)
Minimum Dose Rate (Peak)	10 μGy/s (70 mR/min)
Uncertainty	10% or 0.3 mm Al
Time	
Range	1 ms – 999 s
Resolution	0.1 ms
Bandwidth	4 Hz – 4 kHz*
Uncertainty	0.5%
* Automatically adjusted depending on signal level	
Pulses	
Range	1 – 9999 pulses
Minimum Dose Rate (Peak)	0.5 μGy/s (3.5 mR/min)
Pulse Rate	
Range	0.1 – 200 pulses/s
Minimum Dose Rate (Peak)	0.5 μGy/s (3.5 mR/min)
Dose/Pulse	
Range	1 nGy/pulse – 999 Gy/pulse (0.1 μR/pulse – 999 R/pulse)
Minimum Dose Rate (Peak)	0.5 μGy/s (3.5 mR/min)
Waveforms	
Resolution	62.5 μs*
Bandwidth kV	0.1 – 0.4 kHz**
Bandwidth Dose Rate	4 Hz – 4 kHz**
* Automatically reduced for exposures longer than 1.5 s	
** Automatically adjusted depending on signal level	



RaySafe X2 Mam Sensor

Weight	42 g (1.5 oz)
Size	14 x 22 x 79 mm (0.5 x 0.9 x 3.1 in.)
Sensitivity Angles	Dose, kVp, HVL: 10° Dose (tomosynthesis): 30° See images below
Active Compensation	
Beam quality independent for the following ranges:	
Dose/Dose Rate & HVL	No selections needed. With or without paddle, with or without phantom.
Mo/Mo, Mo/Rh	20 – 40 kVp
Rh/Ag	27 – 40 kVp
Mo/Al, W/Rh, W/Ag, W/Al, Rh/Rh, Rh/Al	20 – 50 kVp
Mo/Cu, Rh/Cu, W/Cu, W/Ti	40 – 50 kVp
kVp	User selectable beam qualities. Paddle compensation available when relevant.
W/Ag	20 – 40 kVp
W/Al	20 – 50 kVp Measuring above 40 kVp requires an X2 R/F Sensor + 2 mm Al (incl.)
W/Rh	18 – 40 kVp
Mo/Mo	18 – 40 kVp
Mo/Rh	32 – 40 kVp using + 2 mm Al (incl.)
Rh/Ag	27 – 40 kVp
Mo/Cu, W/Cu, W/Ti	40 – 50 kVp, using the X2 R/F Sensor
Dose	
Range	1 µGy – 9999 Gy (0.1 mR – 9999 R)
Uncertainty	5%
Dose Rate	
Range	10 µGy/s – 300 mGy/s (70 mR/min – 2000 R/min)
Uncertainty	5%

kVp	
Range	18 – 50 kVp* Measuring above 40 kVp requires an X2 R/F Sensor and on W/Al +2 mm Al (incl.)
Minimum Dose	50 µGy (6 mR)
Minimum Dose Rate (Peak)	10 µGy/s (70 mR/min)
Uncertainty	2% or 0.5 kV (without paddle) 2% or 0.7 kV (with paddle)
* Depending on beam quality, see active compensation	
HVL	
Range	0.2 – 3.6 mm Al
Minimum Dose	1 µGy (0.1 mR)
Uncertainty	5% above 25 kV 10% below 25 kV
Time	
Range	1 ms – 999 s
Resolution	0.1 ms
Bandwidth	400 Hz
Uncertainty	0.5%
Pulses	
Range	1 – 9999 pulses
Pulse Rate	
Range	0.1 – 200 pulses/s
Dose/Pulse	
Range	1 µGy/pulse – 999 Gy/pulse (0.1 mR/pulse – 999 R/pulse)
Waveforms	
Resolution	62.5 µs**
Bandwidth	400 Hz
** Automatically reduced for exposures longer than 1.5 s	

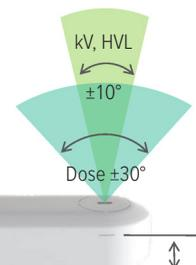

Dose reference height 11 mm

RaySafe X2 CT Sensor

Weight	86 g (3.0 oz)
Size	14 x 22 x 219 mm (0.5 x 0.9 x 8.6 in.), Ø=12.0 mm (0.47 in.)
Standard	For measurements in accordance with IEC 60601-2-44
Active Length	100 mm (3.94 in.)
Energy Dependence	< 5% for 70 – 150 kV (RQR, RQA and RQT beam qualities)
Automatic Environmental Compensation	55 – 110 kPa, 15 – 35 °C (59 – 95 °F)
Dose	
Range	10 µGy – 999 Gy (1 mR – 999 R)
Uncertainty	5%
Dose Length Product	
Range	100 µGycm – 9999 Gycm (10 mRcm – 9999 Rcm)
Uncertainty	5%
Dose Rate	
Range	10 µGy/s – 250 mGy/s (70 mR/min – 1700 R/min)
Uncertainty	5%
Time	
Range	10 ms – 999 s
Resolution	1 ms
Bandwidth	10 Hz
Uncertainty	0.5%
Waveforms	
Resolution	1 ms
Bandwidth	10 Hz

RaySafe X2 Volt Sensor

Weight	55 g (1.9 oz)		
Size	17 x 23 x 93 mm (0.7 x 0.9 x 3.7 in.)		
Input Terminal	BNC connector, 1 MΩ input impedance (BNC-to-banana cable included)		
Voltage			
Range	± 16 V		
Uncertainty	1% or 1 mV, whichever is greater		
Trig Level	50 mV (full bandwidth) or 2 mV (reduced bandwidth)		
Time			
Range	5 ms – 999 s		
Resolution	0.1 ms		
Uncertainty	0.5%		
Waveforms			
Resolution	42 µs*		
Bandwidth	10 kHz (full) / 1.5 kHz (reduced)		
* Automatically reduced for exposures longer than 1 s			
Conversions			
The sensor calculates kV, or mA and mAs, from the measured voltage and selectable conversion factors:			
mA & mAs	1 mA/V	20 mA/V	200 mA/V
	5.06 mA/V	50 mA/V	-200 mA/V
	10 mA/V	100 mA/V	10 A/V
kV	10 kV/V	20 kV/V	27 kV/V
	-10 kV/V	-20 kV/V	

RaySafe X2 Light Sensor

Weight	136 g (4.8 oz)
Size	48 x 60 x 68 mm (1.9 x 2.4 x 2.7 in.)
Classification/Standards	DIN 5032 part 7 class B Complies with relevant parts of AAPM TG18, IEC 62563-1 and IEC 61223-2-5.
Luminance	
Range	0.01 – 10 000 cd/m ² (0.03 – 34 000 fL)
Resolution	0.001 cd/m ² (0.001 fL)
Aperture Angle	5°
Measurement Area	Ø=10 mm (0.4 in.)
Uncertainty Illuminant A	3%
Deviation From Human Eye V(λ) (f₁)	< 3% (see figure Photopic Response)
Illuminance	
Range	0.1 – 100 000 lux (0.01 – 9000 fc)
Resolution	0.01 lux (0.001 fc)
Uncertainty Illuminant A	3%
Deviation From Human Eye V(λ) (f₁)	< 3% (see figure Photopic Response)
Cosine Deviation (f₂)	< 3 % (see figure Cosine Response)

Photopic Response

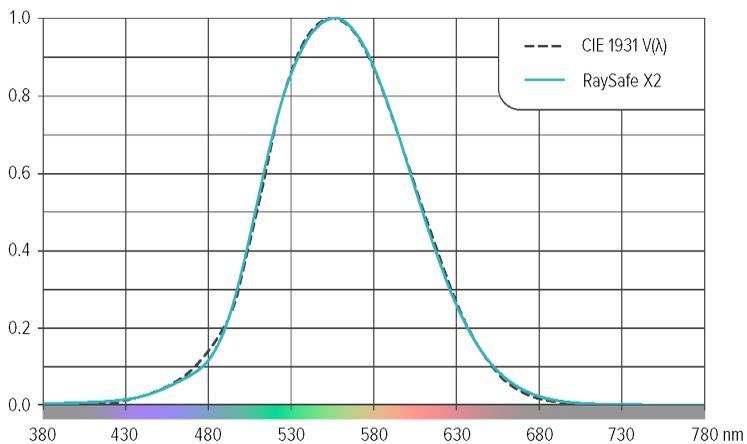

Cosine Response

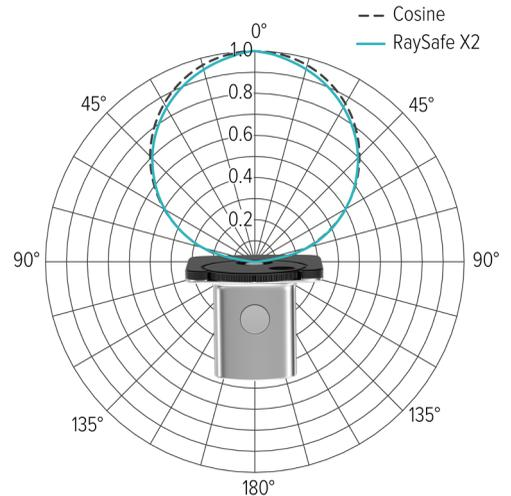

RaySafe X2 Dent Sensor

Weight	42 g (1.5 oz)
Size	14 x 22 x 79 mm (0.5 x 0.9 x 3.1 in.)
Active Compensation	
Beam quality independent for the following ranges:	
Dose/Dose Rate	40 – 130 kVp, 1 – 14 mm Al HVL
kVp	40 – 130 kVp, up to 1 mm Cu
TF	60 – 120 kVp, up to 1 mm Cu
Dose	
Range	1 nGy – 9999 Gy (0.1 µR – 9999 R)
Uncertainty	5% or 5 nGy (0.5 µR)
Dose Rate	
Range	1 µGy/s – 500 mGy/s (5 mR/min – 3400 R/min)
Resolution	1 nGy/s (5 µR/min)
Trig Level	1 µGy/s (7 mR/min)
Uncertainty	5%
kVp	
Range	40 – 130 kVp
Minimum Dose	50 µGy (6 mR)
Minimum Dose Rate (Peak)	10 µGy/s (70 mR/min)
Uncertainty	2%
HVL (Optional)	
Range	1 – 14 mm Al
Minimum Dose	1 µGy (120 µR)
Minimum Dose Rate (Peak)	1 µGy/s (7 mR/min) at > 70 kV 2.5 µGy/s (17 mR/min) at 50 kV
Uncertainty	10%
Total Filtration (Optional)	
Range	1.5 – 35 mm Al
Minimum Dose	50 µGy (6 mR)
Minimum Dose Rate (Peak)	10 µGy/s (70 mR/min)
Uncertainty	10% or 0.3 mm Al

Time	
Range	1 ms – 999 s
Resolution	0.1 ms
Bandwidth	4 Hz – 4 kHz*
Uncertainty	0.5%
* Automatically adjusted depending on signal level	
Pulses	
Range	1 – 9999 pulses
Pulse Rate	
Range	0.1 – 200 pulses/s
Dose/Pulse	
Range	1 nGy/pulse – 999 Gy/pulse (0.1 µR/pulse – 999 R/pulse)
Waveforms	
Resolution	62.5 µs*
Bandwidth kV	0.1 – 0.4 kHz**
Bandwidth Dose Rate	4 Hz – 4 kHz**
* Automatically reduced for exposures longer than 1.5 s	
** Automatically adjusted depending on signal level	

RaySafe X2 Survey Sensor

Weight	140 g (4.9 oz)
Size	14 x 66 x 192 mm (0.5 x 2.6 x 7.6 in.)
Active Compensation	H*(10) – when selecting Sv Air kerma – when selecting Gy or R
Trig Mode	
Manual	Manual start and stop of measurement
Auto	Trig level (N80): 10 µGy/h (1.2 mR/h) or 20 µSv/h
H*(10)	
Range	0 nSv – 9999 Sv
Resolution	1 nSv
Uncertainty	10%, N-series 20 – 150 kV
H*(10) Rate	
Range	0 µSv/h – 150 mSv/h
Uncertainty	10% or 0.3 µSv/h, N-series 20 – 150 kV
Air Kerma	
Range	0 nGy – 9999 Gy (0 µR – 9999 R)
Resolution	1 nGy (0.1 µR)
Uncertainty	5%, RQA 50 – 150 kV 10%, N-series 40 – 150 kV

Air Kerma Rate	
Range	0 µGy/h – 100 mGy/h (0 mR/h – 10 R/h)
Uncertainty	5% or 0.3 µGy/h (0.03 mR/h), RQA 50 – 150 kV 10% or 0.3 µGy/h (0.03 mR/h), N-series 40 – 150 kV
Mean Energy	
Range	30 – 120 keV
Uncertainty	10%
Minimum Dose Rate	10 µSv/h or 10 µGy/h (1 mR/h)
Defining Standard	ISO 4037-1
Time	
Range	0.1 – 9999 s
Resolution	0.01 s
Bandwidth	1 Hz
Waveform	
Resolution	10 ms
Bandwidth	1 Hz
Minimum Dose Rate	1 µSv/h or 1 µGy/h (0.1 mR/h)

Typical Response

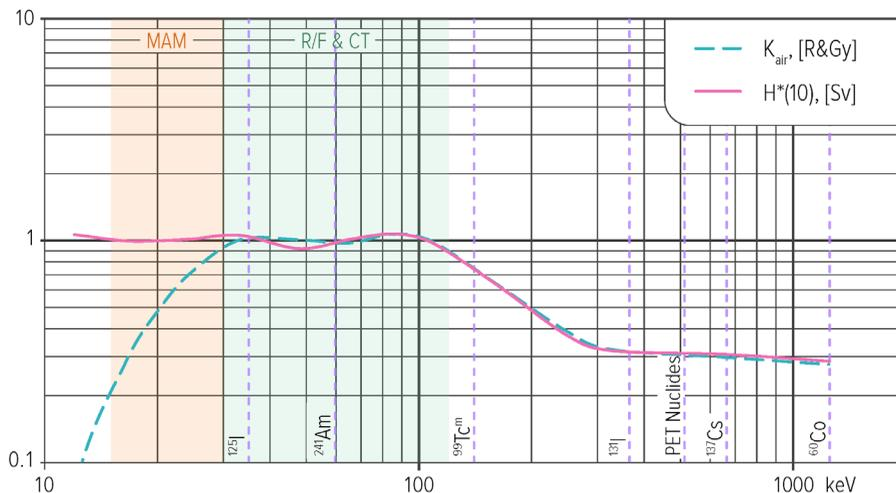

RaySafe ThinX

General	
Weight	< 70 g (2.5 oz)
Size (H X W X L)	13 x 45 x 108 mm (0.5 x 1.8 x 4.3 in.)
EMC Tested	According to EN 61000-6-1:2007 and EN 61000-6-3:2007
Exposure Needed	One
Power On	Auto, radiation triggered
Power Off	Automatic after 2.5 min of inactivity
Reset	Automatic
Battery	3V, CR 2450
Battery Life Time	2 years of typical use
Read-out	128 x 64 pixel LCD
Trig Level	0.1 Gy/s (0.7 R/min)
Models	
RaySafe ThinX Intra	Dose, dose rate, kVp, HVL, time, pulses
RaySafe ThinX Rad	Dose, dose rate, kVp, HVL, time, pulses
RaySafe ThinX Rad kVp	kVp, time, pulses
RaySafe ThinX Rad Dose	Dose, dose rate, HVL, time, pulses
Active Compensation	
Range (Rad)	1.5 mm Al – 0.5 mm Cu total filtration 45-125 kVp 2.5 – 10 mm Al total filtration 125-150 kVp
Range (Intra)	1.5 – 10 mm Al total filtration 45-100 kVp
Dose	
Range	20 µGy – 999 mGy at >70 kV (2.3 mR–114 R) Minimum dose at 50 kV is 100 µGy (11.4 mR))
Resolution	1 µGy (0.1 mR)
Uncertainty	5%)

Dose Rate	
Range	0.1 mGy/s – 100 mGy/s at >70 kV (0.7 R/min–685 R/min) Minimum dose rate at 50 kV is 0.5 mGy/s (3.4 R/min)
Resolution	0.01 mGy/s (0.1 R/min)
Uncertainty	5%
kVp	
Range (Rad)	45 – 150 kVp
Range (Intra)	45 – 100 kVp
Resolution	0.5 kVp
Uncertainty	3%
HVL	
Range	1.0 – 10.0 mm Al
Resolution	0.1 mm Al
Uncertainty	10% or 0.2 mm Al
Exposure Time	
Range	10 ms – 10 s
Resolution	1 ms
Bandwidth	0.5 kHz
Uncertainty	0.5%
Pulses*	
Range	3 – 999 pulses, max 375 ms dead time between pulses
Uncertainty	1 pulse

* If the X-ray generator waveform is pulsed the instrument will also automatically display pulses.

RaySafe DXR+

General				
Weight	75 g (2.6 oz)			
Size (H X W X L)	15 x 30 x 145 mm (0.59 x 1.18 x 5.71 in.)			
Range	± 5 cm (± 2 in.)			
Segment Sensors/ Read-out	41 solid state sensors and corresponding LCD display segments			
Segment Resolution	0.25 cm (0.1 in.)			
Function Test	All segments should turn on when the RaySafe DXR+ is fully irradiated.			
Power On	Automatic when exposed			
Power Off	Automatic after 1 min of inactivity			
Reset	Automatic			
Battery Life Time	6 – 8 years (CR1632) based on 2000 exposures per year			
Operating Temperature	10 – 40 °C (50 – 104 °F)			
Storage Temperature	-20 – +60°C (-4 – +140°F)			
Recommended Generator Settings				
	Mammo	Radiography		
kVp	Max	50	70	100
mA	>100	>200	>100	>50
SID (cm)	<65	<100	<100	<100
Exposure time: >10 ms. No added tube filtration				

RaySafe Pro-Fluoro 150 Phantom

Weight	3.0 kg (6.6 lbs)
Dimensions	300x300x18.5 mm (12x12x0.73 in.)
Standards	DIN 6868-150, and DIN 6868-4
General	
1.5 mm thick copper plate with mesh pattern embedded in PMMA	
17-step copper wedge (thickness 0 to 3.48 mm) with additional low contrast details, Ø 4 mm (0.16 in.)	
Eight circular detail contrast elements, Ø 10 mm (0.4 in.)	
Pattern for line pair resolution evaluation (from 0.6 to 5.0 line pairs/mm)	
Markings to determine the size and position of the effective radiation field	
Print on both sides, indicating tube side and detector side	
Filter set with 0.5 mm Cu, 1 mm Cu and 25 mm Al	
Fluoroscopy stand for easy positioning of the phantom on a table. Includes holder for chest wall mounting.	
Comes in a robust case with room for all parts	

RaySafe Pro-Digi Radiography Phantom

Weight	2.46 kg (5.42 lbs)
Dimensions	310 x 310 x 14 mm (12.2x12.2x0.55 in.)
Standards	DIN 6868-58 and DIN 6868-13
General	
1 mm (0.039 in.) thick copper plate embedded in PMMA	
7-step copper wedge	
6 low contrast elements	
Free area for signal calibration and dose measurements	
Pattern for line pair resolution evaluation (from 0.6 to 5.0 line pairs/mm)	
Markings to determine the size and position of the effective radiation field	
Marks for correct orientation	
Cone for perpendicular X-Ray beam control in the range of 0-1.5°	
25 mm (0.98 in.) aluminium filter - patient equivalent	
Includes holder for chest wall mounting	
Comes in a robust case with room for all parts	

RaySafe P 3D Fluoro Phantom

Dimensions	120x120x60 mm (4.72x4.72x2.36 in.)
Weight	1.0 kg (2.2 lbs)
Material	PMMA, 3 plates glued together where the inner plate holds drillings for spatial resolution tests with Ø 0.50, 0.60, 0.70, 0.80, 0.90, 1.00, and 1.30 mm (0.020, 0.024, 0.028, 0.031, 0.035, 0.039, and 0.051 in.) One extra drilling Ø 2.5 mm (0.098 in.) through all 3 plates
Standards	DIN 6868-150
General	
Delivered in a hard case	

RaySafe Pro-CT Dose Phantom

Material	PMMA material with 1.19 g/cm ³ density
Standards	IEC 61223-3-5 and IEC 61223-2-6
Adult Body	
150 mm (5.0 in.) thick homogenous PMMA cylinder. Ø 320 mm (12.6 in.) with four Ø 13.1 mm (0.52 in.) CT probe holes, 90° apart and 10 mm (0.39 in.) from the edge	
Adult Head/Pediatric Body	
150 mm (5.0 in.) thick homogenous cylinder. Ø 160mm (6.3 in.), with four Ø 13.1 mm (0.52 in.) CT probe holes (90° apart and 10 mm (0.39 in.) from the edge	
Pediatric Head	
150 mm (5.0 in.) thick homogenous cylinder. Ø 100 mm (3.9 in.), with five Ø 13.1 mm (0.52 in.) CT probe holes, one in the middle and 4 around the perimeter, 90° apart and 10 mm (0.39 in.) from the edge	
General	
Acrylic rods for plugging all holes in the phantoms	
Engraved crosshair markings on phantoms for easier positioning	
Comes in a heavy duty Storm Case with interior to also fit an X2 Base Unit, an X2 R/F Sensor and an X2 CT Sensor	

RaySafe Adult Head and Body CTDI Phantom

Material	PMMA material with 1.19 g/cm ³ density
Standards	Standards: IEC 61223-3-5 and IEC 61223-2-6
Adult Body	
150 mm (5.0 in.) thick homogenous PMMA cylinder. Ø 320 mm (12.6 in.) with four Ø 13.1 mm (0.52 in.) CT probe holes, 90° apart and 10 mm (0.39 in.) from the edge	
Adult Head	
150 mm (5.0 in.) thick homogenous PMMA cylinder, Ø 160 mm (6.3 in.), with five Ø 13.1 mm (0.52 in.) CT probe holes, one in the middle and four around the perimeter, 90° apart and 10 mm (0.39 in.) from the edge	
General	
Acrylic rods for plugging all holes in the phantoms	
Engraved crosshair markings on phantoms for easier positioning	
Comes in a heavy duty Storm Case with interior to also fit an X2 Base Unit, an X2 R/F Sensor and an X2 CT Sensor	

RaySafe Pro-Mam AEC BR Phantom

Material	Composition to simulate breast tissue (50% glandular, 50% adipose)
Standards	Compliance with, but does not hold an accreditation: 2018 ACR Digital Mammography Quality Control Manual
Dimensions and Weight	
Overall Dimension (h x w x d)	Three 20 mm plates: 20 x 125 x 100 mm (0.8 x 4.9 x 3.9 in.) Two 10 mm plates: 10 x 125 x 100 mm (0.4 x 4.9 x 3.9 in.) One 5 mm plate: 5 x 125 x 100 mm (0.2 x 4.9 x 3.9 in.)
Weight	20 mm plate: 62 g (2.2 oz.) 10 mm plate: 123 g (4.3 oz.) 5 mm plate: 246 g (8.7 oz.)

RaySafe Pro-Mam Accreditation Phantom

Material	PMMA
Standards	Compliance with, but not yet accredited: <ul style="list-style-type: none"> • ACR Mammography Accreditation Program Requirements • ACR Stereotactic Breast Biopsy Accreditation Program
Dimensions and Weight	
Overall Dimension (h x w x d)	44 x 102 x 108 mm (1.7 x 4.0 x 4.3 in.)
Cut-out Dimension (h x w x d)	7.25 x 81.5 x 82 mm (0.29 x 3.21 x 3.23 in.)
Simulates	42 mm (1.7 in.) compressed breast of average glandular/adipose composition
Weight	556 g (1.23 lb)
Wax Insert Test Elements	
Thickness	7.25 mm (0.29 in.)
Nylon Fiber Diameters (6)	1.56, 1.12, 0.89, 0.75, 0.54, 0.40 mm (0.061, 0.044, 0.035, 0.030, 0.021, 0.016 in.)
Aluminum Oxide Microcalcifications Specks (5)	0.54, 0.40, 0.32, 0.24, 0.16 mm (0.021, 0.016, 0.013, 0.0094, 0.0063 in.)
Tumor Like Masses (Thickness) (5)	2.00, 1.00, 0.75, 0.50, 0.25 mm (0.079, 0.039, 0.030, 0.020, 0.010 in.)

RaySafe Pro-Mam Biopsy Phantom

Material	PMMA
Standards	Compliance with, but does not hold an accreditation: <ul style="list-style-type: none"> • ACR Mammography Accreditation Program Requirements • ACR Stereotactic Breast Biopsy Accreditation Program

Dimensions and Weight	
Overall Dimension (h x w x d)	46 x 80 x 70 mm (3.1 x 2.8 x 1.8 in.)
Cut-out Dimension (h x w x d)	6.25 x 60 x 60 mm (0.25 x 2.4 x 2.4 in.)
Simulates	42 mm (1.7 in.) compressed breast of average glandular/adipose composition
Weight	316 g (0.70 lb)
Wax Insert Test Elements	
Nylon Fiber Diameters (4)	0.93, 0.74, 0.54, 0.32 mm (0.037, 0.029, 0.021, 0.013 in.)
Aluminum Oxide Microcalcifications Specks (4)	0.54, 0.32, 0.24, 0.20 mm (0.021, 0.013, 0.0094, 0.0079 in.)
Tumor Like Masses (Thickness) (4)	0.25, 0.50, 0.75, 1.00 mm (0.0098, 0.020, 0.030, 0.039 in.)

RaySafe Pro-Stand

General	
Height	Adjustable height from 350-600 mm (11.8-23.6 in.), for a wide magnification range
Positioning	Standard & Full versions: Adjustable high and horizontal position. Full version: Possibility to tilt with an angle of 10 degrees for easier positioning on mammography systems. Includes a positioning tool for easy setup
Standards	Complies with the following standards: <ul style="list-style-type: none"> • IEC 60336:2005 • IEC 61223-3-1, 2, 4:1999
Case	Standard version: Cardboard with fitted inlay Full version: Heavy duty rugged case for safe transportation
Compatibility	Used with our pinholes and the RaySafe Pro-slit Camera

RaySafe Pro-Slit Camera

General	
Dimensions	40 x 40 x 10 mm (1.57x1.57x0.39 in.)
Slit Size	0.01 mm (3.9 ·10 ⁻⁴ in.) wide and 10 mm (0.39 in.) long slit with 8° spread
Nominal Focal Spot Range	Supports the range described in IEC 60336:2020 for the slit evaluation method: 0.1 mm (3.9 ·10 ⁻³ in.) to 3.0 mm (0.12 in.)
Material	Tungsten embedded in PMMA and brass
Standards	Complies with the following standards: <ul style="list-style-type: none"> • IEC 60336:2020 • IEC 61223-3-1, 2, 4:1999

Pinholes

General	
Diaphragm Material	90:10 gold-platinum alloy
Diaphragm Dimensions	Ø 5 x 1.5 mm
Pinhole Diameter	See table below
Optional Mounting Screw	Yes
Optional Mounting Frame for Pro-Stand	Yes
Standards	Complies with the following standards: <ul style="list-style-type: none"> • IEC 60336:2020 • IEC 61223-3-1:1999 • IEC 61223-3-2:2007 • IEC 61223-3-4:2000 • EN 12543-2:2021 • ASTM E1165-12

Test Patterns

General	
Model 07-501-2000	1.0-4.8 LP/mm, 16 groups, 0.1 mm Pb, 110x40 mm
Model 07-523-2000	0.5-5.0 LP/mm, 1 group, 0.1 mm Pb, 157x50 mm
Model 07-539	1.5-20.0 LP/mm, 1 group, 0.025 mm Pb, 80x30 mm
Model 07-535	0.6-5.0 LP/mm, 20 groups, 0.05 mm Pb, 50x50 mm

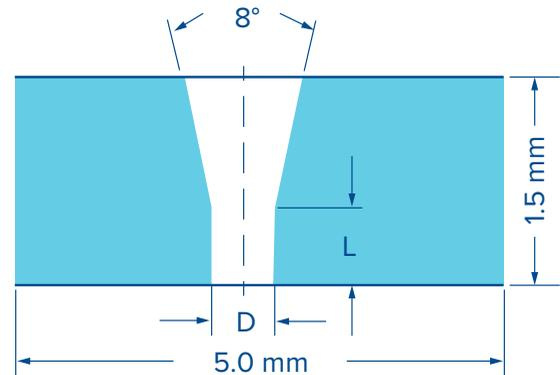

Model	Pinhole Diaphragm Dimensions (mm)		Focal Spot Sizes (mm)	Standard
	D	L		
07-633	0.010±0.005	0.020±0.010	0.1-0.3	EN 12543-2:2021
07-613	0.030±0.005	0.075±0.010	>0.3-1.0	EN 12543-2:2021
			0.1-3.0	IEC 60336:2020
07-617	0.075±0.005	0.35±0.010	>1.2-2.5	ASTM E1165-12
07-611	0.100±0.005	0.50±0.010	>1.0	EN 12543-2:2021